

MegaMet does not supply Bolts or Fasteners

PLEASE VERIFY ANCHORS

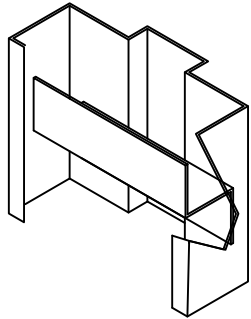

Z ANCHOR DETAIL

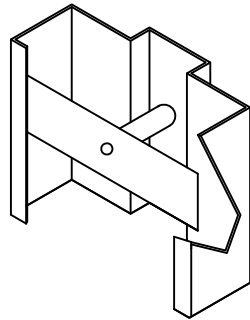

EXISTING WALL ANCHOR (EWA) DETAIL

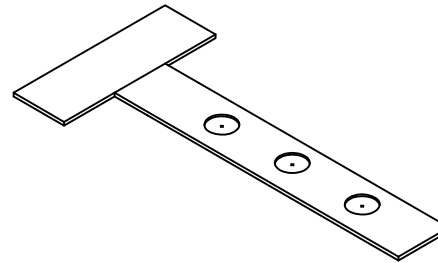

Tee ANCHOR DETAIL

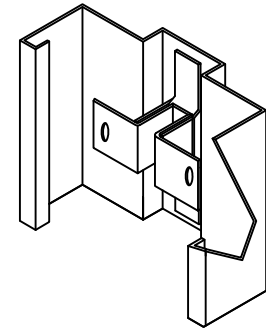

COMPRESSION BAR ANCHOR (CBA) DETAIL

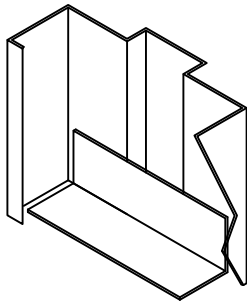

FLOOR CLIP DETAIL

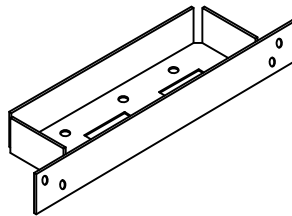

MULTI-PURPOSE SLIP IN ANCHOR

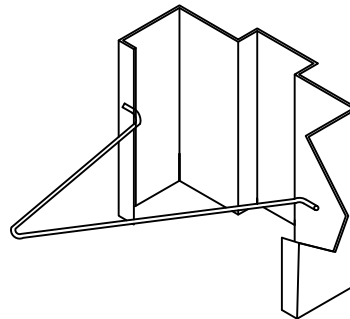

WIRE ANCHOR DETAIL

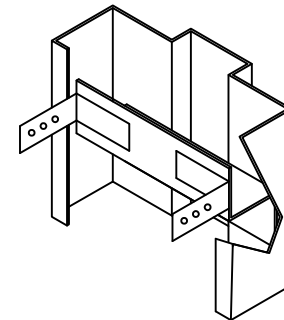

WSC W/ WSA ANCHOR DETAIL

TOLERANCE ON ALL DIMENSIONS UNLESS OTHERWISE SPECIFIED FRACTIONAL  $\pm .3/32"$  DECIMAL  $\pm 0.0937$

CUSTOMER:	
ARCHITECT:	
CONTRACTOR:	

ALL INFORMATION CONTAINED IN THIS DISCLOSURE WHETHER PATENTABLE OR OTHERWISE COMPRISES PROPRIETARY INFORMATION OF MEGAMET INDUSTRIES, INC. AND ITS UNAUTHORIZED USE OR PUBLICATION WITHOUT THE EXPRESS CONSENT OF MEGAMET INDUSTRIES, INC. IS STRICTLY PROHIBITED.

Manufactured by  
**MEGAMET INDUSTRIES, INC.**  
Birmingham, Alabama

NAME	ANCHORS

DRAWN	DATE
K. MCPHERSON	10-28-13
CHECKED	SCALE
	NONE
APPROVED	PROJECT

	REV.